

Door Armor Double Side Light Door Application

A Jamb Shield

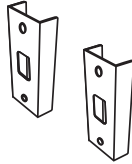



B Mini Door Shields (2)

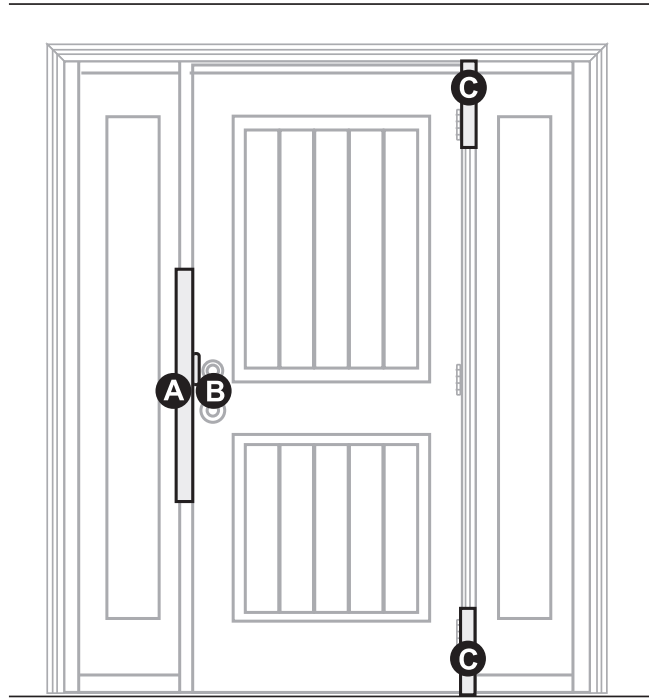
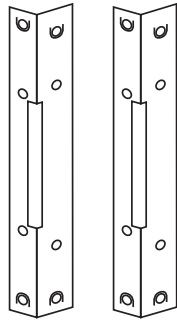

C Hinge Shields (2)



D  2-1/2" screw (16) (painted head)

E  3-1/2" screw (12) (painted head)

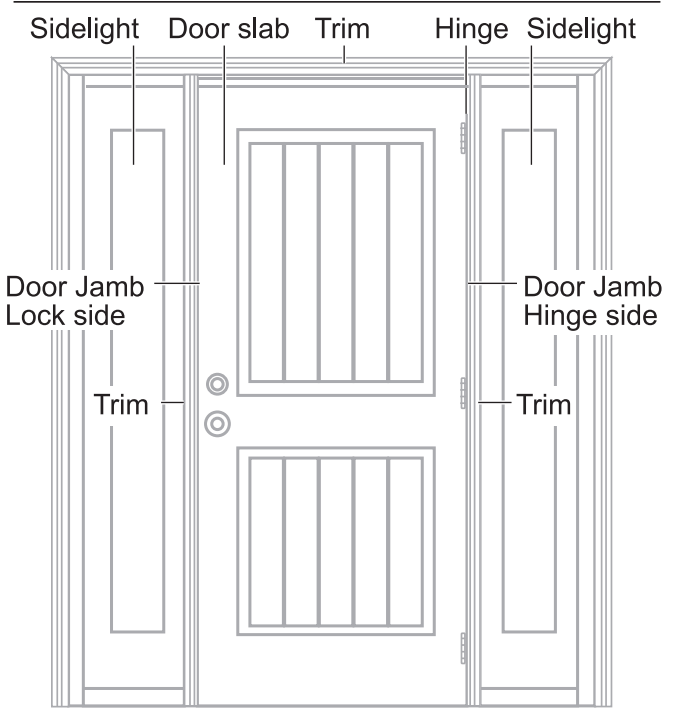

Questions? Call customer service at 1-888-582-2294 or visit www.armorconcepts.com

SAFETY INFORMATION

WARNING

- The use of work gloves and safety glasses is strongly recommended while installing this product. Wood and metal shaving/splinters can cause serious bodily injury.
- As with all products requiring installation, to reduce the possibility of accidental injury to you or others.

FOLLOW ALL INSTALLATION INSTRUCTIONS contained herein accurately and carefully.

PREPARATION

Before beginning assembly of product, make sure all parts are present. Compare parts with package contents list and diagram above. If any part is missing or damaged, do not attempt to assemble the product. Contact customer service for replacement parts at 1-888-582-2294 or visit www.armorconcepts.com.

PAINTING INSTRUCTIONS

Note: It is recommended that components be painted before being installed. They can be touched up as necessary after installation.

1. Using plain steel wool or a very fine emery cloth, gently rough the surface of the piece to be painted. You only want to rough the surface and break the gloss so that your paint will adhere to the surface. Do not totally remove the existing powder coating.
2. Clean the surface with a tack cloth or a cloth with a cleaner on it that will not leave a residue. Rubbing alcohol will work well for this application. You can also use mineral spirits but make sure that whatever you use does not cause an adverse reaction with the powder coating.
3. When components are clean and free of debris, you are ready to paint your pieces.
4. Ensure that all components are completely dry before handling or installing them.

Tools required for assembly

- Variable speed Impact drill, with screwdriver adapter
- Pair of work gloves per person assisting in installation
- Pry bar
- Pair of safety glasses per person assisting in installation
- Carpenter's level
- 11/64 in. drill bits
- Claw foot hammer
- Razor knife
- Flathead screwdriver
- Caulk

Door Shield Installation

1. Slide the Mini Door Shield **B** onto the door position so the holes will go over the lock bolts.

2. Using the supplied 2-1/2" screws **D**, secure the Door Shield to the door slab using the hole above and below screw lock bolt holes.

3. With the Door Shields in place, make sure the Door Shields are level and flush against the door slab on all sides.

4. Verify that the locks can function properly without interference from the Door Shields. If there is interference, adjust the Door Shields until the locks operate freely. If there is no interference, the installation is complete.

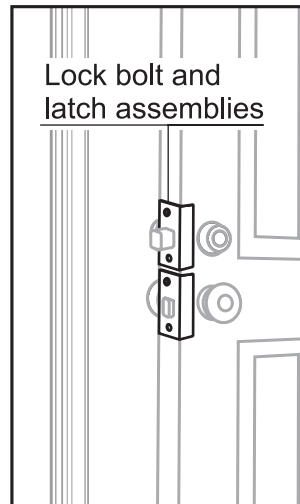
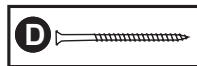
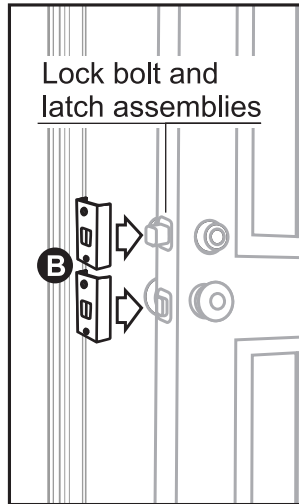

Door Jamb Prep

⚠ Note: In all steps it is imperative to ensure that at no time any drilling or screw placement come in contact with the glass casement of the sidelight.

1. Carefully score along trim edges with sharp tool such as a razor knife.

2. Gently pry and remove trim molding on the sidelight panels that is immediately adjacent to the door jamb exposing the door jamb separating the door and sidelights.

NOTE:

(This trim can and should be reinstalled upon installation completion.)

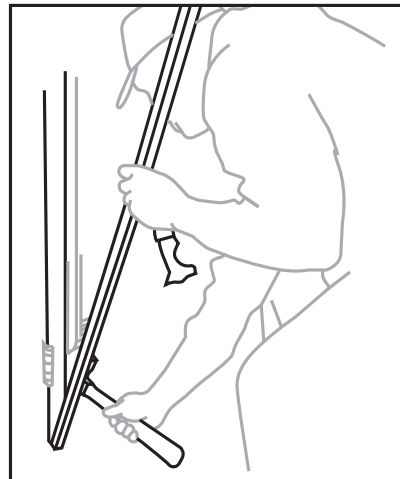

Jam Shield

1. Locate the Center Jamb Shield support piece **A** with multiple cutouts along one side, (3) 2-1/2 inch **D** and (6) 3-1/2 inch **E** screws.

2. Position the piece along the center section of the lock side door jamb ensuring the lock bolt holes of the door jamb are aligned with the appropriate cutouts on the piece. With the component flush against the interior edge of the door jamb, predrill with 1/64th-inch drill bit and install the central side screw, from the door side, with the supplied 2-1/2 inch screw **D**.

Repeat for top and bottom screw holes.

! Be sure to use a screw that will not come into contact with the glass of the side light.

3. Pre-drill the holes on the interior 1/64th-inch drill bit and secure the Shield in place with the supplied 3-1/2 inch screws

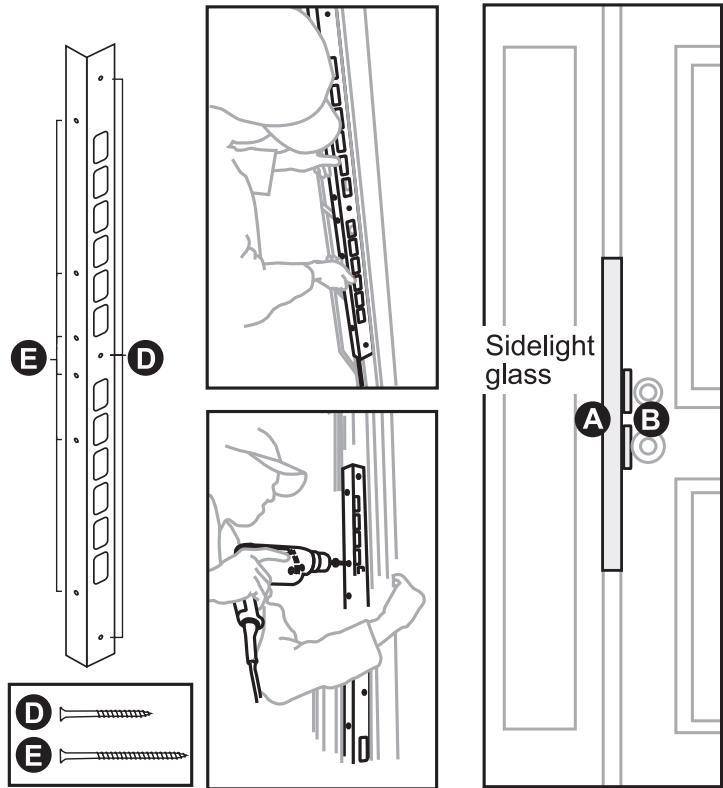

4. Clean all debris from the lock bolt holes and ensure the lock operates freely and engages smoothly into the holes of the Center Jamb Shield and door jamb.

Top Shield

1. Locate the Hinge Shield support **C**, (4) 2-1/2" **D** and (4) 3-1/2" **E** screws.

2. Remove the screws attaching the hinge to the door. Save these screws as they will be needed to reattach the hinge to the door.

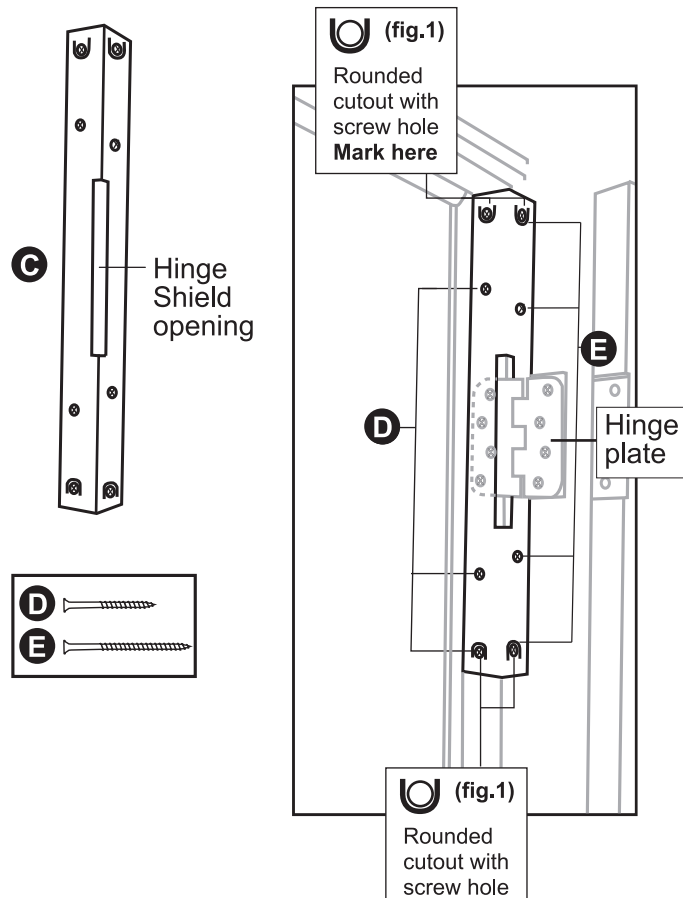

3. With the door hinge plate free, maneuver the support between the door and the jamb so that the unsecured hinge plate goes through the opening in the support.

4. There are four (4) rounded cutouts (fig. 1) with the screw holes in their center that will be located on the inside center (2) and door side (2) of the support piece. The upper tabs will be positioned so as to attain maximum penetration into the upper rough frame.

5. Hold the piece in position on the jamb. Ensure the door side edge of the support slides behind the weather stripping. Once the support piece is positioned properly, mark the center of the rounded cutout of the upper tabs on the door jamb (fig. 1).

6. Remove shield and with a 1/2-inch drill bit, drill 1/2-inch holes approximately 1/2-inch deep into the jamb at the marked locations.

7. Remove the two screws from the upper jamb side hinge plate, closest to the weatherstripping. Pre-drill these holes with the 11/64-inch drill bit. Now drive a 2-1/2 inch screw (D) into each of these holes, ensuring the screw heads come to rest flush the hinge plate.

8. Re-install the support piece and ensure it is located so the circular tab is positioned over the previously drilled hole and the piece is still properly positioned, as detailed in step 5. (If there is difficulty due to hole misalignment, enlarge the hole slightly to accommodate the bending of the tab)

9. With a pin punch or other appropriate blunt instrument and hammer, tap the cutout tab so that it bends into the predrilled 1/2-inch hole.

The upper tab should be positioned so that when the screw is installed, maximum penetration into the upper rough frame can be realized.

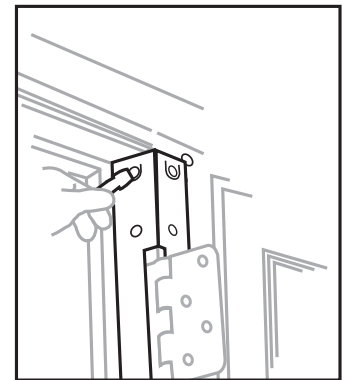
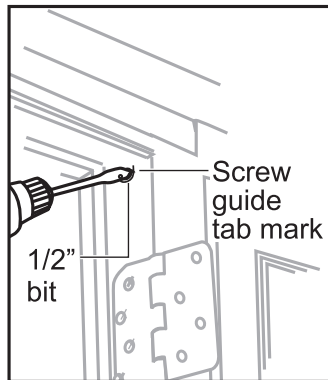
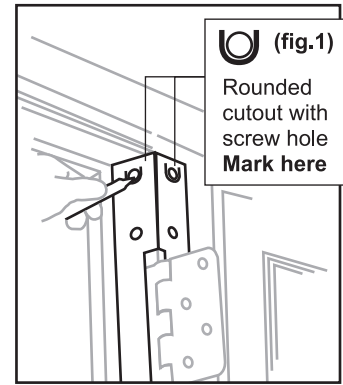

NOTE: Above, door is removed for illustrative purposes only. Application or hinge shield should not require removal of door.

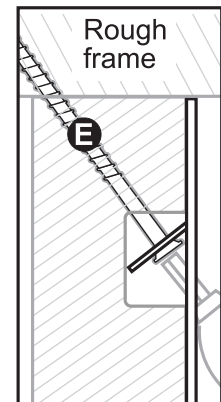
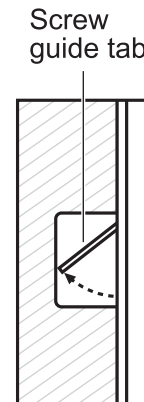
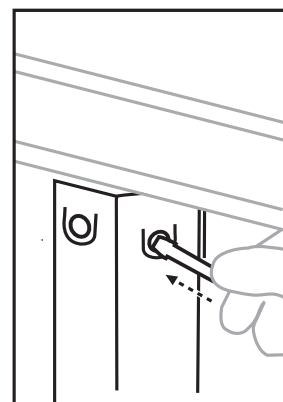

10. Pre-drill the hole in the upper tab ensuring the drill bit goes on an upward angle through the vertical door jamb, upper horizontal jamb and as far as possible into the upper rough frame. Then secure the upper tab with the supplied 3-1/2 inch screw

11. Predrill with 11/64th-inch drill bit and install all other screws as detailed.

⚠ Be sure to use a screw that will not come into contact with the glass of the side light.

12. Reattach the hinge to the door with the previously removed screws.

Bottom Shield

1. Locate the second Hinge Shield support **C**, (4) 2-1/2" **D** and (4) 3-1/2" **E** screws.

2. Remove the screws attaching the lower hinge to the door. Save these screws as they will be needed to reattach the hinge to the door.

3. With the door hinge plate free, maneuver the support between the door and the jamb so that the unsecured hinge plate goes through the opening in the support.

4. There are four (4) rounded cutouts (**fig. 1**) with the screw holes in their center that will be located on the inside edge (2) and door side (2) of the support piece. The lower tabs will be positioned so as to attain maximum penetration into the floor.

5. Hold the piece in position on the jamb. Ensure the door side edge of the support slides behind the weather stripping.

Once the support piece is positioned properly, mark the center of the rounded cutout of the lower tabs on the door jamb (**fig. 1**).

6. Remove shield and with an 11/64" drill bit, drill 11/64" holes approximately 1/2 inch deep into the jamb at the marked locations.

7. Remove the two screws from the lower jamb side hinge plate, closest to the weatherstripping. Pre-drill these holes with the 11/64 inch drill bit. Now drive a 2-1/2 inch screw **D** into each of these holes, ensuring the screw heads come to rest flush the hinge plate.

8. As with the previous Hinge Shield, repeat the re-install, align and punching of the circular tabs.

Angle the lower tabs to obtain maximum penetration into the sill plate and floor.

9. Pre-drill center holes with a 11/64th-inch drill bit in the lower tabs ensuring the drill bit goes on a downward angle through the vertical door jamb, sill plate and as far as possible into the floor.

10. Secure the lower tabs with a supplied 3-1/2 inch screws **E**.

11. Pre-drill with 11/64th-inch drill bit and install all other screws as detailed.

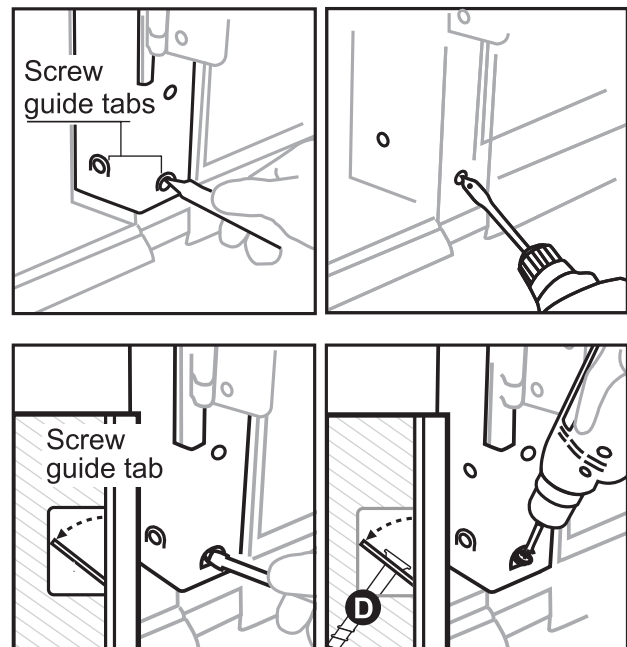
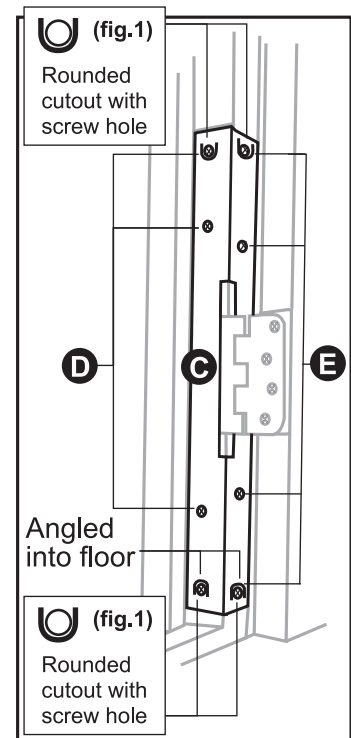

⚠ Be sure to use a screw that will not come into contact with the glass of the side light.

12. Reattach the hinge to the door with the previously removed screws.

Finishing

1. Once installation is complete verify the door is true and operates correctly. If not take the necessary steps to ensure proper operation and then proceed.

2. Install the interior trim molding and caulk as necessary.

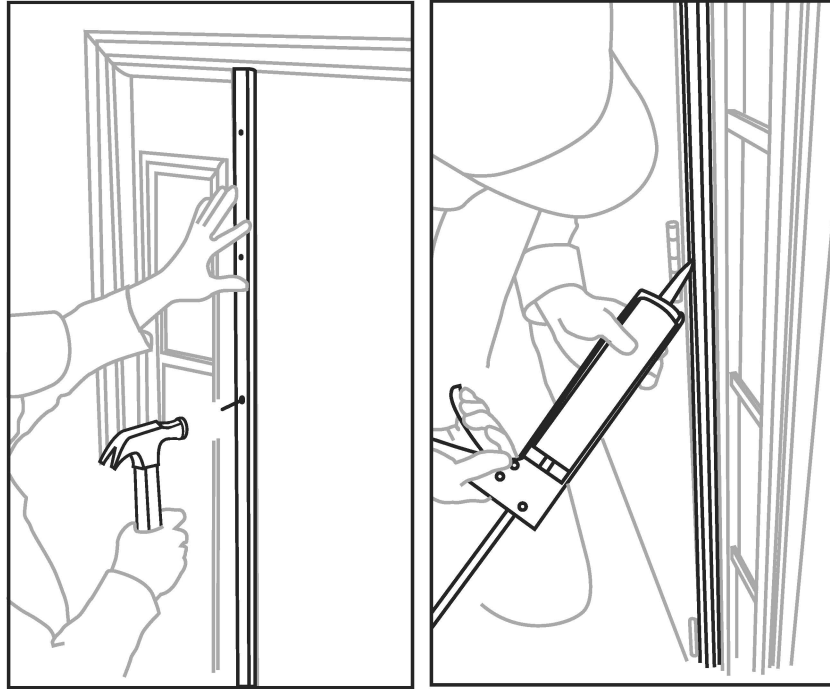

Armor Concepts has products for most style doors
For more products and information, contact Armor Concepts
Customer service - 888-582-2294 or visit www.armorconcepts.com



Door Armor

Ultimate Door Security
Armor Concepts LLC 888-582-2294